

Edition: A/0  
Publication Date: July, 26, 2021

# ROBAM

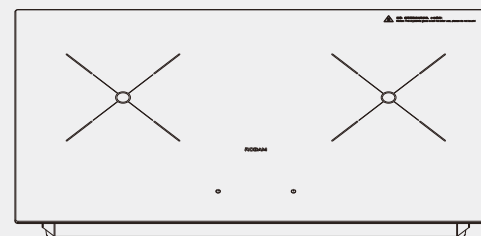

## User Manual

If the manual is lost, you can send e-mail to [overseas@robam.com](mailto:overseas@robam.com), request for an electronic manual.

**CS34-W2984**  
**CS34-W2985**

Induction Cooker



# Contents

Safety Precautions .....	1
Product introduction .....	6
Product Structure .....	7
Product Parameters .....	8
Installation Instruction .....	8
Use Instruction .....	9
Electrical Schematic Diagram .....	12
Cleaning and maintenance precautions .....	13
Attachment .....	13
Common Faults and Fault Dropping .....	14

## Safety Precautions

In order to avoid any harm or property damage to the users and other persons, following distinctions and signs are specially given. All these are the important notices concerned with safety, so please abide by these notices strictly. And, please use this product correctly on the premise that all the contents herein are understood fully.

Distinctions on contents made in accordance with extent of harm and damage

 Danger	Personal risk, serious injury or a fire may be very likely caused if this sign is neglected and the product is operated improperly.
 Warning	Personal risk, serious injury or a fire may be caused if this sign is neglected and the product is operated improperly.
 Notice	Personal injury or damage to objects may be caused if this sign is neglected and the product is operated improperly.

Signs of the behaviors that shall be paid attention to or that shall be prohibited





 Please use this product strictly in accordance with contents of this Operation Manual. Our company is not reliable for any property loss or personal injury caused by improper using of this product.

### Danger

 **Abide by strictly**  
When pulling out the plug from the socket, you must pull it out by holding the end of the plug by hand. Please do not pull the plug by hand power lead, otherwise it is prone to electric shock, short circuit, fire and other dangers.

### Danger

 **Abide by strictly**  
Do not use a loose or poorly contacted power outlet, as this may lead to electric shock, short circuit, fire and other hazards.

 **Abide by strictly**  
In case of face plate rupture, it must be power dump immediately to avoid possible electric shock and be replaced by our special service point.



 **Abide by strictly**  
Keep the whole machine away from heat sources, gas and alcohol and other fire goods products.

 **No touch**  
The surface temperature of the face plate apparatus will become hot during use, and 1 hour after use, you should not touch the surface of the face plate with your hands, because face plate there is still residual temperature to avoid burns.



 **Abide by strictly**  
For cans of sealed food, please open the lid before heating to avoid the risk of explosion due to heat expansion.

 **Abide by strictly**  
Accessible parts of the appliance may get hot when in use, so children should stay away.







 **Danger**

-  **Prohibited** Do not place combustible items such as paper, cloth, aluminum foil, etc. between face plate and the cookware or at the bottom of the induction cooker for heating. To avoid the danger of burning when working.
-  **Prohibited** Small metal objects such as knives, forks, spoons, etc. are not allowed to be placed directly on face plate to avoid the risk of burns.
-  **Prohibited** It is strictly forbidden to put the utensils on the metal countertop to work in order to avoid danger.

 **Warning**

-  **Abide by strictly** If the power cord is damaged, to avoid danger, it must be replaced by the manufacturer, its maintenance department or a similar department specialized persons.
-  **Abide by strictly** Please use a 16A outlet alone, do not use the same power outlet with several appliances at the same time, and make sure the outlet is safely and effectively grounded.
-  **Abide by strictly** This engine block should be placed horizontally. It must not be placed close to the wall or objects, with a clearance of at least 100mm on each side, and the air outlet must be kept clear.

 **Warning**

-  **Abide by strictly** Do not use close to water sources or flush directly with water to prevent malfunction caused by water entering the air suction port and air outlet.
-  **Abide by strictly** Use should be far away from high temperature heating appliances such as gas stove, when the ambient temperature is too high, it may cause the induction cooker overheating protection, temporarily stop heating.
-  **Abide by strictly** Please place the cookware in the center of face plate heating area to avoid uneven temperature of the cookware to deform it.
-  **Prohibited** Dry firing of pots and pans is strictly prohibited to avoid damaging the machine and pots and pans.
-  **Prohibited** Prohibit unattended young children and disabled people from using this appliance, and prohibit children from playing with the appliance.
-  **Prohibited** It is strictly forbidden to insert foreign objects such as wire and screws into the suction and outlet to prevent danger such as electric shock.
-  **Prohibited** Non- specialized persons may not install, disassemble and repair or replace parts without authorization.

**! Notice**

**! Abide by strictly** Do not use force or hard objects to knock face plate, in handling, installation, to take lightly to avoid damage face plate.

**! Abide by strictly** Prevent cockroaches and other small insects from entering the inside of the machine by the suction and outlet to prevent machine failure.

**! Abide by strictly** If water accumulates in the area of the touch button during the use of the appliance, please wipe it with a dry cloth in time to avoid the malfunction of the touch button.

**! Abide by strictly** Please use the special cookware for this product or buy the special cookware for our induction cooker. It is best not to use other substitutes to avoid adverse effects on the performance of the induction cooktop and service limit.

**Applicable pots, pans and containers**

Pans made of iron (enamel, cast iron, SSTstainless steel) or magnetic induction, with a flat bottom diameter of 100mm or more and 260mm or less.

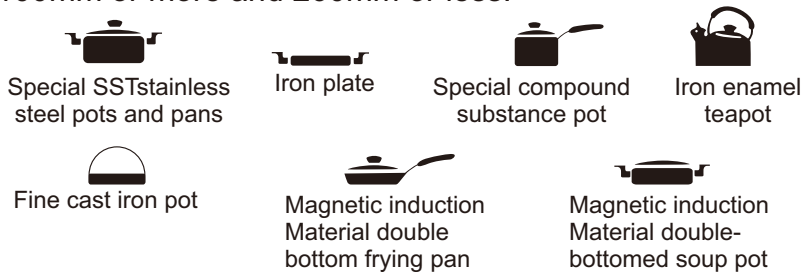

**Not applicable pots, pans and containers**

Pots and pans made of ceramic, glass, aluminum, copper, pots and pans with bottom diameter less than 100mm, pots and pans with uneven bottom

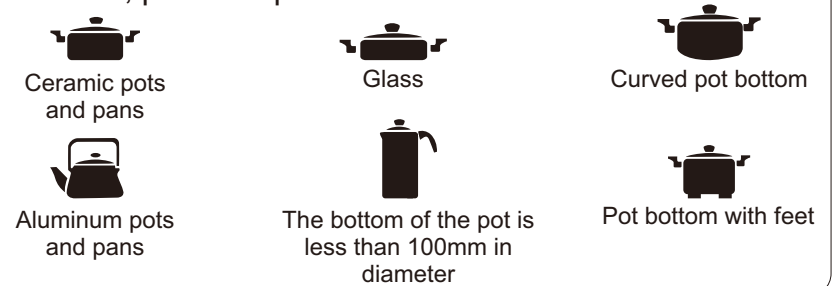

**Product introduction**

Dear users.

Let us take this opportunity to express our gratitude for your purchase of the Boss Induction Cooktop. We especially recommend that you have the need to read this instruction manual and save it for future reference before you proceed to install and use this product.

Our company is a professional manufacturer of household appliances and kitchenware such as range hoods and gas cookers in China. Boss brand induction cooker adopts advanced design concept, focusing on overall design, optimized shape, heating efficiency high and safe to use. It has been qualified by national testing institutions at all levels and is a recommended product for the construction of national administrative authority residential communities. The unique electric code anti-counterfeiting mark is used to ensure that users buy genuine products and safeguard their own interests.

### Important Information

#### Packaging of Induction Cooker

Please dispose these packaging materials in an environment-friendly way, in order to keep a good environment.

Be sure not to allow children to play with the packaging materials (e.g. plastic film and carton box, etc.), otherwise it would lead to suffocation accident. So, please keep children away from the packaging materials.

### Product Structure

(This picture is only for your reference.)

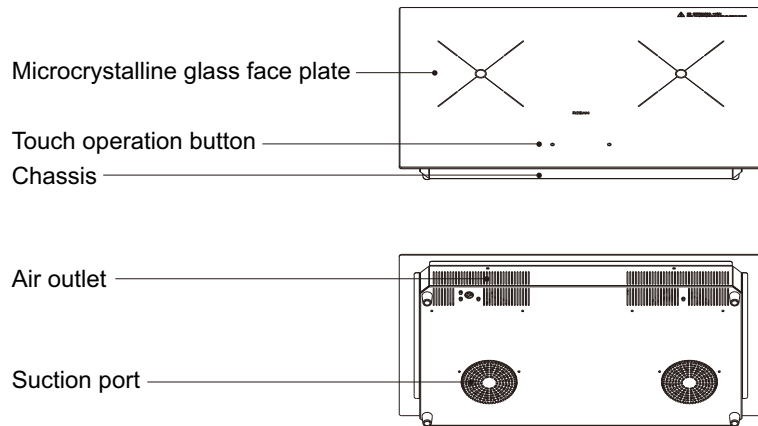

### Product Parameters

Item Name	Induction Cooker
Model	CS34-W2984 CS34-W2985
Rated Voltage	220-240V~
Rated Frequency	50-60Hz
Left burner maximum power	2200W
Right burner maximum power	2200W
Rated Power	3400W
Dimensions(mm)	780×450×97
Net Weight(kg)	9.9
Hob Element Number	2
Panel	Glass ceramic
Size Of Openings(mm)	700×400×R10

#### Note:

1. The parameters in the table are for reference only, the specific data to the cooker on the nameplate shall prevail.
2. induction cooker hole size, the size of the hole sample in the carton shall prevail.
3. The company reserves the right to change the product design and specifications.

### Installation Instruction

1. When installing the induction cooker, the distance between the air outlet strip and the wall is not less than 10 cm, and the upper part of the induction cooker should have a net height of more than 100 cm. If a hood is installed, this space is set according to the installation requirements of the hood.
2. The cabinet where the induction cooker is installed should have an opening size (area of not less than 100 square centimeters) that meets the ventilation requirements and is connected to the atmosphere.
3. The induction cooker built-in should be dug according to the marked size (as shown below).

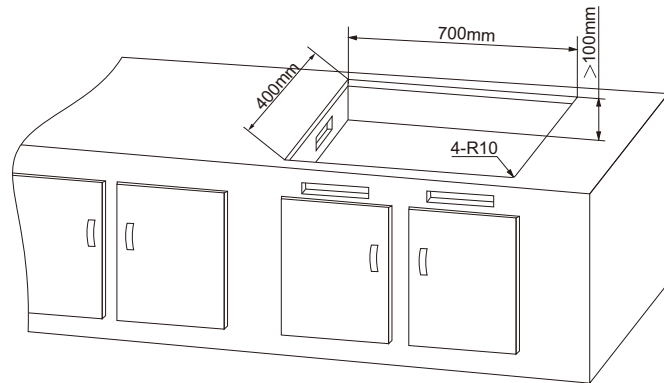

4. Power lead The connection must be convenient to ensure that the induction cooker can be disconnected from the power supply at any time after installation, please use a separate 16A socket, please do not use the same power socket with several appliances at the same time, and ensure that the socket is safely and effectively grounded.

## Use Instruction

### Control face plate Operating Instructions

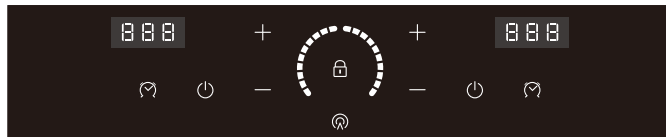

#### 🔒 Child lock key.

Long press this key to lock the current function and working state to prevent false operation; press other keys are invalid (except the on/off key).

#### 🕒 Timer key.

In the working state, press this key to set the timer to shut down.

#### 🔌 On/off key.

In the off state, press this key to turn on the power; you can press this key to turn off the power in any state.

#### + Adjusting key(large):

Press this key in working state to adjust the fire power, each press increases the fire power, long press increases continuously until the maximum gear fire power. In the timer state, press this key to adjust the timer time, each press will increase 1 minute, long press will increase continuously. In standby mode, press this key to enter the working state.

#### 📶 Networking function.

The product can be connected with Boss Electric intelligent hood products, long press the networking button for pairing, the networking icon flashes at this time, and the networking icon lights up long after successful connection, if the connection fails, please reconnect or contact the after-sales service.

#### - Adjusting key(small):

In the working state, press this key to adjust the fire power, each press to reduce the fire power, long press to continuously reduce until the minimum fire power. In the timer state, press this key to adjust the timer time, each press decreases 1 minute, long press decreases continuously.

### Performance characteristics

1. The power control is divided into 10 grades, corresponding to the following table, the minimum 400W continuous power, including 200W grade for intermittent heating.

F1	F2	F3	F4	F5	F6	F7	F8	F9	F10
200W	400W	600W	1000W	1200W	1400W	1600W	1800W	2000W	2200W

2. Timing shutdown function: In the working state, you can set the timing shutdown function, the maximum timing time is 180 minutes (can be cyclically set).

3. With safety child lock function.

#### Power on

Turn on the power, the buzzer sounds once, the digital tube with all pilot lamp flashes for a while and then goes off, the induction cooker is in the off state.

**Power**

In the off state, press "⏻" key to turn on the cooker, the buzzer will sound once, enter the standby state, the digital tube will display "---" statically, no key operation within a few minutes, enter the off state.

**Heating and temperature adjustment**

In the standby state, press "+" key, enter the working state (default fire power 5 gears), start working, you can adjust the fire power size by "+" or "-", the fire power setting range in F1 -F10 between.

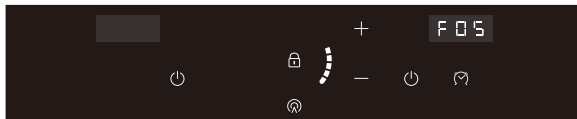

**Timer shutdown setting**

For example: set the induction cooker to turn off after 20 minutes of heating.

**Timer setting steps:**

- ① When the induction cooker is in working condition, short press "⌚" key, the display shows the default timing time and flashes.
- ② Press the "+" or "-" key again to adjust the time, set the time to "20";
- ③ After setting, short press the "⌚" key or the key is not operated within several seconds, the timing function starts. The display shows the timing time and start counting down, when the set time reaches, the buzzer beeps to indicate and enter the shutdown state.

Note: In the timing, if you need to adjust or view the power then press "+" or "-" key, the digital tube shows the current gear, press "+" or "-" key to adjust the power, adjust the completion of a few seconds to return to the current timing time.

**Timing time change:**

In the process of use if you need to change the time, you can short press the "⌚" key again to enter the timing setting state. Then reset the time by "+" or "-" key.

**Timing function cancellation:**

If the user wants to cancel the timing function, long press the "⌚" key to cancel.

**Child lock setting**

In standby and working state, press and hold the "🔒" key for several seconds, the tone will sound and the child lock pilot lamp will light up, locking the current state, except the "🔒" key, pressing other keys (except the on/off button) is invalid; if you want to unlock, press and hold the "🔒" key again for several seconds to unlock.

**Network connection function**

In the standby and working state, long press "📶" key to start networking, "📶" key to fast flash to find the network, "📶" key to slow flash network matching. If the match is not successful within a few minutes, the "📶" key will be half lit, and when it is successful, the "📶" key will be long lit.

Note: If you press "📶" key short while networking, the networking is canceled. Press and hold it again after successful networking to re-match the network.  
This device contains radio transmission module with the model approval code: CMIIT ID: 2019DP4506.

**Power-off**

After use, press the "⏻" key, the induction cooker stops heating, and the fan stops running automatically after running for a period of time to dissipate heat.

**Electrical Schematic Diagram**

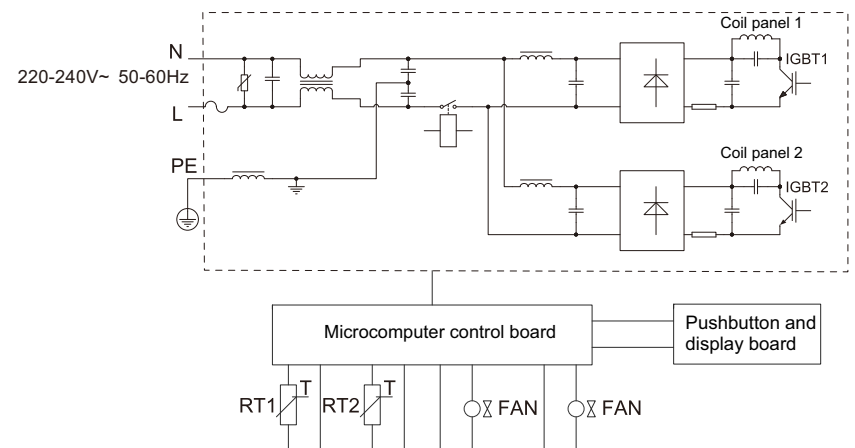



## Cleaning and maintenance precautions

Before cleaning, please unplug power lead from the socket and wait for the induction cooktop face plate to cool down.

Do not unplug the induction cooktop directly while it is working, it should be turned off first and unplugged after the fan stalled out, which is good for prolonging the induction cooktop service limit.

### Cleaning method of induction cooker

Engine block, face plate.

Wipe with a soft wet wipe, for the oil that is not easy to wipe, use neutral detergent to wipe, then wipe with a soft wet wipe until no trace is left; do not use a wire ball to scrub, so as not to scratch the surface, wipe dry with a dry wipe after scrubbing.

Air-absorbing and air-emitting hole position surface.

The dust can be removed with a cotton swab, such as oil stains, can be removed carefully with a toothbrush and a little cleaner that does not damage the utensil.

### Attention:

- Do not use gasoline, benzene and other solvents to wipe engine block. Suction port and air outlet easily adsorbed dust, must be cleaned regularly, available soft bristle brush or dust extractor clean, otherwise too much dust accumulation in the suction port will affect the induction cooker service limit.
- Every time you finish using the power off, wait for a while (face plate no longer hot), please clean the induction cooktop in time to avoid residual dirt on the face plate repeatedly heated by the bottom of the pot, which is difficult to clean and cause face plate dirty discoloration over time.
- Do not use steam cleaners to clean.
- If there are cracks on the surface, please turn off the induction cooktop and stop using it to avoid possible electric shock.

## Attachment

1. One copy of the Operation Manual
2. One copy of Installation templet

## Common Faults and Fault Dropping

SN	Common faults	Fault check	
1	when plugged in, did not hear a buzzer sound, press the power button and the light does not light.	①Whether the plug is inserted tightly. ②Whether the power is out. ③Whether the power supply, socket, safety wire, power lead are intact.	
2	digital tube shows either F01-F10, but not heating.	①whether the pot used is suitable. ②For other reasons, please send it to the special maintenance network for repair.	
3	sudden termination of heating in use.	① whether the temperature of the surrounding environment is very high. ② whether the air suction and exhaust ports are blocked. ③ whether the timing time has arrived. ④Sometimes it is the role of the protection device, wait a few minutes ④Sometimes the protection device works, wait for a few minutes and then use the power. ⑤Is there no operation up to 2 hours during use.	
4	Fault code appears	E0、E5、E6、E7、Ed	Send to the authorized maintenance network for repair.
		E1	If the pot is positioned correctly or replaced with a suitable pot, work can be resumed.
		E2	Wait for a period of time and resume work after the cooker temperature returns to normal.
		E3、E4	After power supply voltage is normal, work can be resumed automatically.

### Note:

If the power cord is damaged, to avoid danger, it must be replaced by the manufacturer, its maintenance department or a similar department specialized persons.

If the above phenomenon still can not be ruled out, please contact our special maintenance point or dealer, it is strictly forbidden for non- specialized persons to disassemble this machine by itself.