

ROBAM

Edition: A/0
Publication Date: July, 10, 2022

ROBAM

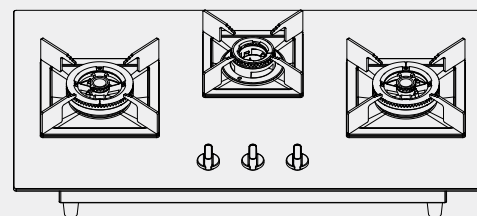

User Manual

If the manual is lost, you can send e-mail to overseas@robam.com, request for an electronic manual.

JZ(Y/T)-ZG730B
JZ(Y/T)-ZG830B

Gas Hob

Contents

Notice Items	1
Important Safety Information	3
Product Overview	5
Product Structure	6
Product Features	6
Product Parameter	7
Installation Instruction	9
Use Instruction	11
Clean and Maintenance	12
General Troubleshooting	13
Attachment	13

General Troubleshooting

Problem	Possible Reason	Measurement
Ignition Failure	Gas Valve is not open	Turn off the control switch Then turn on the gas valve
	Air exists in gas pipe	Exhaust the air by igniting repeatedly
	The rubber tube is twisted or blocked	Straighten, clean or replaced the rubber tube
	Electrode needle is dirty	Clean clear
	Ignitor malfunction or the electrode needle in wrong position	Adjust the electrode needle to burner, keep the distance 3.5-4mm
The burner is not work when loosen the knob	Without battery, put battery oppositely or power insufficiency.	Install the battery collectly or replace the battery
	The copper core, copper cover, burner is in wrong position	Install the copper core, copper cover, burner in right position
	The damper adjuster too big and flame left burner.	Adjust the damper
Gas leakage (gas smell)	Time to press On/Off switch is too short.	Keep the switch down 3-5 seconds then loosen
	Switch is not closed completely.	Turn off the switch
Burning abnormal or sounding noise	The rubber tube is not connected or cracked.	Connect rubber tube or replace it
	The damper is not adjusted correctly.	Adjust damper
	Burner is blocked	Clear away the block
	The gas used here is not consonant with the required in the nameplate.	Choose the cooktop properly
	Gas pressure is unstable, water in the rubber tube.	Get rid of water in the rubber tube

Attachment

1. One copy of the Operation Manual
2. Two pieces of anchor ear (except for metal soft pipe)
3. One copy of Installation templet
4. One piece of battery in the packing foam
5. Set of limiters (JZY-ZG830B/JZT-ZG830)

Notice Items

1. Please make sure the source of gas is in line with that noted on nameplate before your installation of the product, otherwise it is strictly prohibited to use.
2. The minimum distance between the gas stove and gas resource should be no less than 1 meter and connecting tube should be the matched special gas tube, which should be replaced once a year at a regular limitation. The regular length of the tube should be 1-1.5 meter as preferred. It is highly required that the tube should be avoided from pressing, heavy bending or aging. The joining point should be carefully checked to avoid any possibility of leaking and any potential damage from the leaking.

WARNING: THE GAS STOVE SHOULD BE ONLY CONNECTED BY THE QUALIFIED SPECIAL TUBE(e.g. the tube made of UV-PSA, Buna-N rubber). IT IS HIGHLY PROHIBITED FROM USING NORMAL RUBBER TUBE, FOR THE POSSIBLE CHEMICAL REACTION MAY HAPPEN WHEN THE NORMAL RUBBER TUBE MEET OZONE/LIQUID OIL, WHICH WILL POSSIBLY CAUSE THE DAMAGE OF THE TUBE AND THE RELATED POTENTIAL ACCIDENTS.

3. Leave the valve of the gas inflow tube under normal situation. The leaking test should be done after any abnormal change of the valve. (Put the low-concentrated cleaning solution to the joint point and then turn on the valve to check whether any air bubble appears, if there were any air bubble, the valve should be turned off immediately and fix the problem. It cannot be used until the problem is completely solved).

4. The fixing metal joint should be installed strictly according to the operation manual, which lays in the “package of the fixing metal joint” or installed by the professional staff, if the tube is connected by the fixing metal joint. The test of leaking should be done before use. (The way of leaking test above is for your reference).
5. The gas stove should be installed on the place of well-ventilated, but should be avoided from the strong wind.
6. Do not try to cover the flame on the gas stove, or put anything tinder around. Besides the gas stove cannot be used to for drying towel or clothes, etc.
7. Do not have the immediate touch on the flame-around area, such as work stand, burner or cooktop after the use of the gas stove.
8. Do not try to beat the cooktop, and the special attention should be paid to keeping the gas stove in good condition during the transport and installation.
9. Once any leaking tested, the valve should be turned off immediately and the window should be open to keep ventilated. The electric fan or range hood or any other electric appliances are prohibited to use, and keep the fire away. Meanwhile, please contact professional staff.
10. If there were any abnormal sound such as whirl heard, or the color of flame turned from dark to light or turned muddy, the backfire from the burner might be happened. Please turn off the switch, and check whether the burner and copper core are well-positioned. Turn on the switch in half a minute after the check.

11. Each time of turn-on the switch should be no more than 20 seconds to avoid from deflagrating. If the switch cannot be turned on within five times, please contact the service immediately.
12. The children are prohibited to use the gas stove in the case of safety concern.
13. The installation and any maintenance should be taken only by the professionals.
14. Be sure to keep your head away from the burner while the operation of turn-on gas stove. Please turn off the valve of gas and switch of gas stove after the use to avoid from any possible accident.
15. Be sure to keep any heat conductor such as metal knife, fork or cover away from the heat.

- ◆ The use of this appliance for any other purpose or in any other environment without the express agreement of ROBAM APPLIANCES CO.,LTD.will invalidate any warranty or liability claim.
- ◆ You should not use this appliance to store items on or as a work surface.
- ◆ Do Not Modify This appliance.
- ◆ You should not store or place flammable or highly flammable liquids/materials on top of or near the appliance. Items made from aluminium, plastic or plastic film should also be kept away from the appliance, as they may fuse to the surface.
- ◆ Repairs may only be carried out by ROBAM APPLIANCES CO.,LTD.service engineers or their authorized service agent.

General Safety

- ◆ Installation must be carried out by an AUTHORISED PERSON in accordance with the regulation in force.
- ◆ Care should be taken to ensure that the units and work surfaces that you build the appliance into, meet with The relevant standards.
- ◆ This appliance is not intended for use by persons(including children)with reduced physical, sensory or mental capabilities, or lack of experience and knowledge, unless they have been given supervision or instruction concerning use of the appliance by a person responsible for their safety.
- ◆ DO NOT USE OR STORE FLAMMABLE MATERIALS IN THE APPLIANCE STORAGE DRAWER OR NEAR THIS APPLIANCE.
- ◆ DO NOT SPRAY AEROSOLS IN THE VICINITY OF THIS APPLIANCE WHILE IT IS IN OPERATION.
- ◆ DO NOT MODIFY THIS APPLIANCE.
- ◆ DO NOT USE THIS APPLIANCE AS A SPACE HEATER.

Child Safety

- ◆ ROBAM APPLIANCES CO.,LTD.strongly recommend that babies and young children are prevented from being near to the appliance and not allowed to touch the appliance at any time. During and after use, all surfaces will be hot.
- ◆ If it is necessary for younger family members to be in the kitchen, please ensure that they are kept under close supervision at all times.
- ◆ Older children should only be allowed to utilise the appliance when supervised.
- ◆ Children should be supervised to ensure that they do not play with the appliance.

During Use

- ◆ Any film or stickers that are present on the hob surface when it is delivered should be removed before use.
- ◆ These instructions are only valid if the country symbol appears on the appliance.If the symbol does not appear on the appliance, it is necessary to refer to the technical instructions, which will provide the necessary instructions concerning modification of the appliance to the conditions of use of the country.

Important Safety Information



General Information

THIS PRODUCT BELONGS TO THE EMBEDDED HOUSEHOLD GAS STOVE, YOUR SAFETY IS OF THE UTMOST IMPORTANCE TO ROBAM APPLIANCES CO.,LTD.PLEASE MAKE SURE THAT YOU READ THIS INSTRUCTION BOOKLET BEFORE ATTEMPTING TO INSTALL OR USE THE APPLIANCE. IF YOU ARE UNSURE OF ANY OF THE INFORMATION CONTAINED IN THIS BOOKLET, PLEASE CONTACT THE ROBAM APPLIANCES CO.,LTD.

- ◆ This appliance is designed for domestic household use and for the cooking and frying of domestic foodstuffs.
- ◆ IMPORTANT: The adjacent furniture and all materials used in the installation must be able to withstand a minimum temperature of 85°C above the ambient temperature of the room it is located in, whilst in use.
- ◆ Certain types of vinyl or laminate kitchen furniture are particularly prone to heat damage or discolouration at temperatures below the guidelines given above.
- ◆ Any damage caused by theappliance being installed in contravention of this temperature limit, will be the liability of the owner.
- ◆ Your new appliance is guaranteed against electrical or mechanical defects, subject to certain exclusio that are noted in ROBAM APPLIANCES CO.,LTD.conditions of guarantee. The foregoing does not affect your statutory rights.

- ◆ Prior to installation, ensure that the local distribution conditions (nature of the gas and gas pressure) and the adjustment of the appliance are compatible.
- ◆ The adjustment conditions for this appliance are stated on the label (or data plate).
- ◆ This appliance is not connected to a combustion product evacuation device. It shall be installed and connected in accordance with current installation regulations. Particular attention shall be given to the relevant requirements regarding ventilation.
- ◆ **CAUTION:** The use of a gas cooking appliance results in the production of heat and moisture in the room in which it is installed. Ensure the kitchen is well ventilated, keep natural ventilation holes open or install a mechanical ventilation device (mechanical extractor hood).
- ◆ **CAUTION:** This appliance is for cooking purposes only. It must not be used for other purposes, for example room heating.
- ◆ Prolonged intensive use of the appliance may call for additional ventilation, for example opening of a window or more effective ventilation, for example increasing the level of mechanical ventilation where present.
- ◆ Care should be used when utilising the appliance, otherwise there is a risk of burns being caused.
- ◆ You should not allow the electrical connection cables to come into contact with the hob surface when it is hot or any hot cookware.
- ◆ If fat and oil overheats, then it can ignite extremely quickly. For this reason, when cooking with fat and oil the appliance should not be left unattended.
- ◆ Make sure that all of the cooking zones are switched off after use.

CAUTION: "In case of hotplate glass breakage:

- shut immediately off all burners and any electrical heating element and isolate the appliance from the power supply
- do not touch the appliance surface
- do not use the appliance."

Product Overview

Dear Users:

Thank for your buying our gas hob. This gas hob adopt advanced technology, fashion design and optimistic structure. This gas hob has high heat efficiency and safe operation, too.

Please read this operation manual carefully before installation or operation of this product. Meanwhile, please keep it properly for future reference.

Product Structure

(This picture is only for your reference. There are series of models, we don't list all of them one by one).

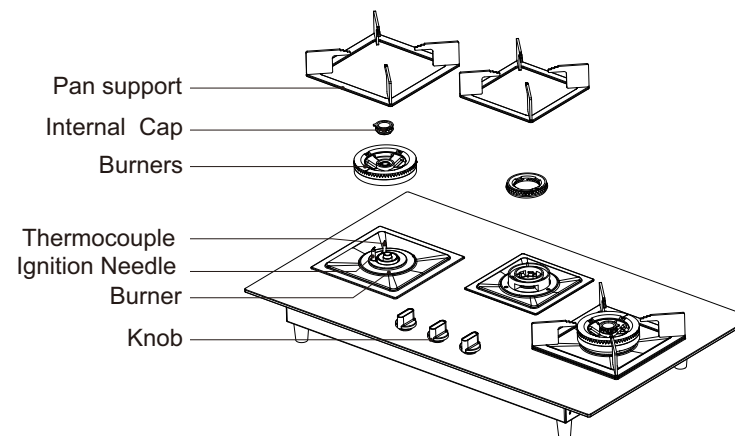

Product Features

1. Fashionable design: The design of model and structure comply with fashion and adapt to modern kitchen.
 2. Excellent quality: Top quality of accessories with trustable quality, long life expectancy.
 3. Electronic pulse with flame failure safety device on each burner and high thermal efficiency.
 4. Full air in flow: Built-in structure with full air in flow, cooktop supplyment air, air valve adjust flexibly, burn completely and easy to install.
 5. Anti-explosive enamel glass, use safely and easy to clean.
 6. Pan Diameter limits
 - Wok burner (5.0kW): 220mm ~ 300mm
 - Semi-rapid burner (1.8kW): 160mm ~ 220mm
- Remark: It's prohibited to use a vessel that overlap its edges.
Using inappropriate hob guards can cause accidents.

Product Parameter

Item Name	Gas Hob	
Model	JZY-ZG730B (Non Malaysia) JZT-ZG730B	JZY-ZG830B (Non Malaysia) JZT-ZG830B
Gas Category, type	See the label	
Rated gas pressure	See the label	
Nominal heat input	See the label	
Gas inlet connection	φ 9.5mm special gas rubber gasket (G1/2" inch special metal gasket)	
Product Size(mm)	780×450×155	860×500×155
Net Weight(kg)	14.4	16
Hob Element Number	3	
Air in flow	Full	
Panel	Tempered Glass	
Size Of Opennings(mm)	700×400	
Ignition Method	Electronic Pulse	
Flame failure safety device	Yes	

Item Name	Gas Hob	
Model	JZY-ZG730B (Malaysia)	JZY-ZG830B (Malaysia)
Gas Category, type	3B/P(30), G30, G31 or their mixtures	
Rated gas pressure	28-30 mbar	
Nominal heat input	Total: 11.8kW (859g/h), Left burner: 5.0 kW (364g/h) Middle burner: 1.8 kW (131g/h) Right burner: 5.0 kW (364g/h)	
Gas inlet connection	φ 9.5mm special gas rubber gasket (G1/2" inch special metal gasket)	
Product Size(mm)	780×450×155	860×500×155
Net Weight(kg)	14.4	16
Injector Dia. (mm)	0.95 & 0.5 (Wok burner) 0.66 (Semi-rapid burner)	
Hob Element Number	3	
Air in flow	Full	
Panel	Tempered Glass	
Size Of Opennings(mm)	700×400	
Ignition Method	Electronic Pulse	
Flame failure safety device	Yes	

Note:

- Parameters indicate for reference only. The exact datas should be confirmed on the nameplate on the gas hob.
- The installation size of built-in gas hob should be confirmed by the specification on the templet in the carton.
- We keep right to alter design or specification.

Installation Instruction

1. When the Gas Hob is installed, the distance from the combustibles is not less than 15cm, and the distance between the Gas Hob and noncombustible should be not less than 7 cm; The Gas Hob and the above object should have a height of more than 100cm, If you want to install a Rang Hood, the height of 65-75cm from the Gas Hob is suitable. (This space is set up according to the installation requirements of the Range Hood).
2. The kitchen cabinet for built-in gas stove should be specially designed for the safety concern. The ventilated borehole should be suitable for the safety requirement and the size should be no less than 100 cm².
3. When the special gas tube is used, one side of the tube should be connected with the gas valve while the other side connected with the inflow side of gas stove. Please take off the cover on the connection point and put the tube to cover the red-mark point, and tighten it with the anchor ear. Be sure that the leaking test should be taken before use.
4. The size of the borehole should be taken according to the requirement, and put the built-in gas stove to match the borehole.
5. If the G1/2" inch connector is used, please make sure to put the rubber gasket inside the connector and the leaking test should be taken before use.
6. The qualified reduction valve should be used when the LPG is used as the source of the gas.
7. Assisting pan stand is available for some models, only applies to ϕ 100mm pan and minimal fire.

Requirement for hole size

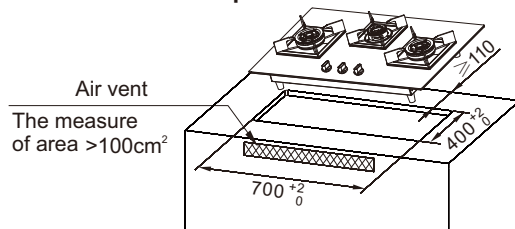

Rubber hose diagram

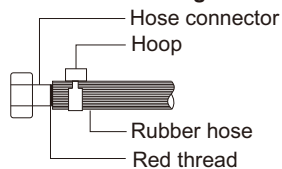

A schematic diagram of a metal bellows

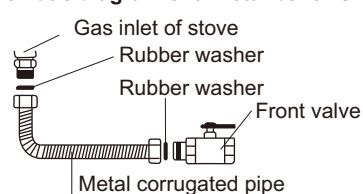

8. When the copper cover is placed, the positioning rod is inserted into the positioning hole on the aluminum seat and is placed in place to ensure that it is not moved.

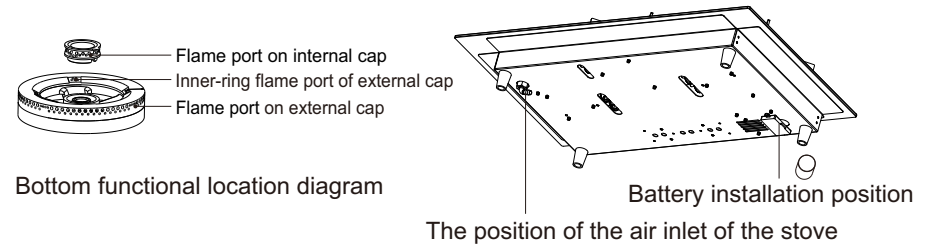

9. This cooker can be adapted to the opening range: 700mm-790mm long and 400mm-440mm wide

If you are replacing the installation, the installation method is as follows:

- ① First, the installer will measure the actual size of the opening in the user's home;
- ② Wipe the adhesive area of the chassis with a clean rag, and then paste the limit pieces (four) to the corresponding positions as shown, with the outer edges aligned to the required installation size. After pasting, press the limiters hard to make them fit tightly (installed by company specialized persons);
- ③ Put the products with sticky limiters into the openings, pay attention to the cooker needs to be flat after placing to ensure that each limiters are embedded in the openings, it is recommended to use the products after 24 hours to ensure that the adhesive cures.

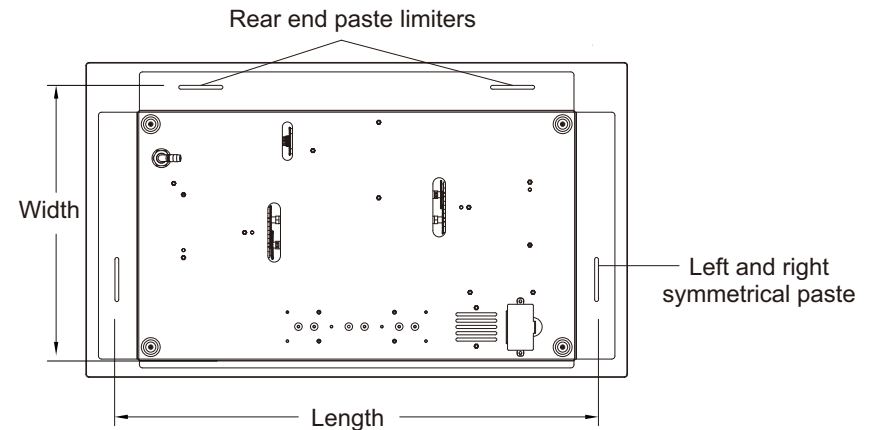

Note: Adjustable chassis function only for JZY-ZG830B/JZT-ZG830 Bmodel.

Use Instruction

1. Be sure the copper core, copper cover, copper base and pan stand in right position. Check the switch first before turn on the valve of the gas. (Pic1)
 2. IGNITION METHOD: Push the switch and turn to 90 degrees anti-clockwise for the strongest flame, (Pic2) meanwhile the poop sound of pulse firing can be heard. The full push should be taken for 3-5 seconds till the flame comes out. Otherwise, the same operation above should be retaken. In addition, push the switch and turn to 90 degrees anti-clockwise again is the small flame. (Pic3)
- Remark: The device shall not be operated for more than 15 s. If after 15 s the burner has not lit, stop operating the device and open the compartment, door and/or wait at least 1 min before attempting a further ignition of the burner.

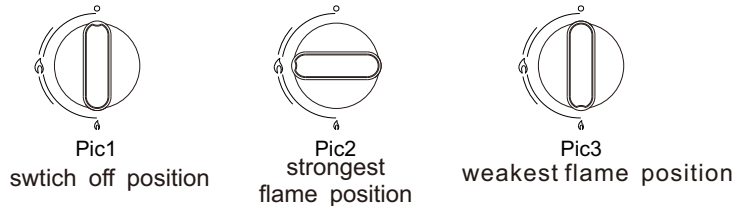

REMARKS: The first ignition or that of the first reuse of the gas stove may not work immediately, because there is air in the tube, it needs to be operated repeatedly.

3. SWITCH-OFF: Turn the switch to the position clockwise (Pic1) and the fire will be switched off.
4. FIREPOWER CONTROL: Operate according to the instruction mark.
5. Airflow control: Please adjust the inlet airflow, to make the gas fully fired. Adjust the inlet spot nail or plate (at the bottom of hobs), by clockwise or anti clockwise, till the flame become stable and blued colored (as following picture). Here is the way to differ the combustion states:

- Combustion well: the flame takes on cyanine, no yellow flame or red fire, the interior and exterior flame is clear.
- Air deficiency: the flame is stretched and takes on yellow or red, the interior and exterior flame is faintly.
- Air superabundance: the flame is unstable, about to leave the fire cover or flame becomes short obviously (sometimes will occur backfire when using manufactured gas), and color of flame appear cyan.

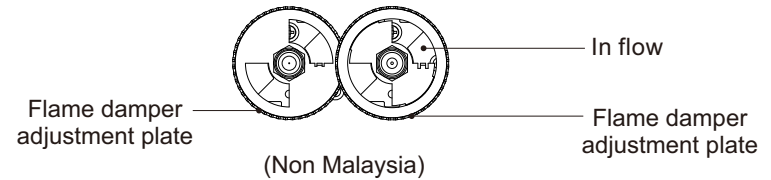

Clean and Maintenance

1. Maintain gas hob surface: Please clean the surface with wet and neutral detergent cloth, and then clean with dry cloth, Don't use steel brush or other rigidity objects.
2. Check if the copper cover, copper core and ornamental ring are shift or biasing, and correct them at the right position in time.
3. Please deal with used battery properly avoiding pollution.
4. This product use environmental and recyclable package, please deal with those packages properly in order to protect environment and reduce waste.
5. If maintenance confirms this product can't be used again, please deal with recyclable materials properly.
6. In order to keep ordinary usage and good combustion regime, operator must clean and dredge the fire hole with brush and steel needle regularly to prevent fire from turning back and damage gas hob. Don't bath this product.

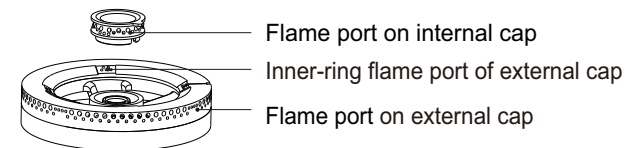

(The figure is provided for reference only and subject to the actual product.)